



M/V 'HC Melina'

Valid as of 09 Oct 2023

Registration	
Call sign	V2FR2
IMO number	9415052
Port of registry	St. John's
Flag state	Antigua Barbuda
Shipyards	Ben Kien Shipyards
Year/Place of delivery	2011/Vietnam
Class	Rina
Class notation	C <input checked="" type="checkbox"/> general cargo ship - double side-skin – equip. for carr. of contr. – heavycargo; unrestricted navigation <input checked="" type="checkbox"/> AUT-UMS; ICE CLASS IA
P&I Club	Steamship Mutual
Tonnage	
DWAT	Abt. 8.850 mt (w tween deck)
DWCC	Abt. 7.900 mt
Gross tonnage	6577
Net tonnage	3002
Dimensions	
Length over all	129,4 m
Length between p.p.	122,1 m
Breadth over all	17,3 m
Breadth moulded	17,0 m
Summer draught	7,2 m
Depth moulded	10,0 m
Height keel to top mast	39,7 m
Hold/hatch sizes	
Number of holds/hatches	2/2
Hold capacity	About 11.070 m ³ /391.000 ft ³
#1 Hatch and hold	25,90* x 13,50 m
#2 Hatch and hold	52,50* x 13,50 m
	*narrow #1 fwd and #2 aft
Weather deck dimensions	82,20 x 13,80 m
Hold height	10,65 m
1 st pos. Tanktop -> Tween deck	7,04 m
Tween deck -> Hatch cover	3,00 m
2 nd pos. Tanktop -> Tween deck	4,84 m
Tween deck -> Hatch cover	5,20 m
3 rd pos. Tanktop -> Tween deck	3,00 m
Tween deck -> Hatch cover	7,04 m
Hold floor surface	Abt. 1.046 m ²
Deck floor surface	Abt. 1.134 m ²
Container capacity	
Hold capacity	228 TEU
Deck capacity	268 TEU (4 reefer)
Total	496 TEU
Stack weight TEU/FEU	Tanktop: 80/100 mt Hatchcovers: 35/54 mt
TEU slots for IMO class 1.1-1.6	All hatch covers and hold #1
IMO class 1.4S	All hatch covers/deck/hold

Deck loads	
Tanktop	16,00 mt/m ²
Tween deck pontoons	3,50 mt/m ²
Hatch covers	1,75 mt/m ²
Hatch covers/Tween deck	
Type of hatch covers	5 + 11 pontoons
Tween deck pontoons	5 + 11 panels
	All moveable by own gantry
	Tween decks can be set as Moveable bulkheads
Propulsion/Maneuvering	
Main Engine	4.000 kW
Bow thruster	500 kW
Propeller	Controllable pitch propeller
Rudder	Spade
Service speed	14,0 kn
Bunkers/Ballast capacity	
ME: MGO LS	617 m ³
AE: MGO LS	69 m ³
Fresh water	125 m ³
Ballast water	4394 m ³
Cargo gear	
Cranes on starboard side	Two x NMF x 80 mt SWL
Load/Outreach	80 mt/4,0-18,0 m 65 mt/4,0-22,0 m 50 mt/3,5-28,0 m
Tandem load	160 mt SWL
Pipe spreader	1 x 19 m x WLL 160 mt
Spreader beams on board	1 x 12 m x WLL 160 mt 2 x 4 m x WLL 80 mt

*All details are believed to be correct but
without guarantee/HWS*

Phone: +45 70 70 13 11
E-mail: europe@ocean7projects.com
Web: ocean7projects.com

HC Melina

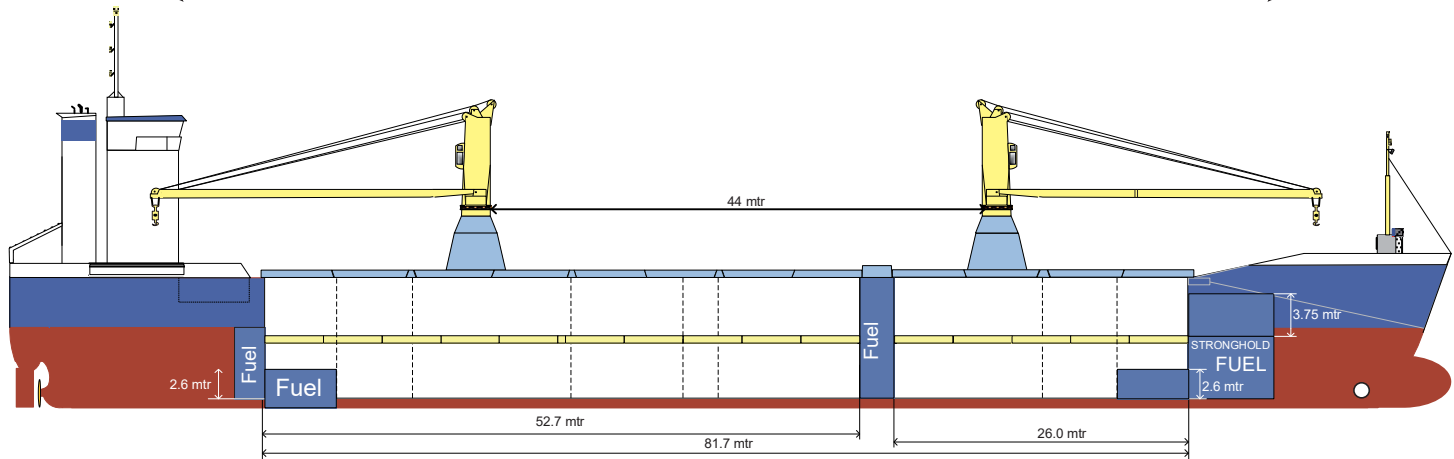
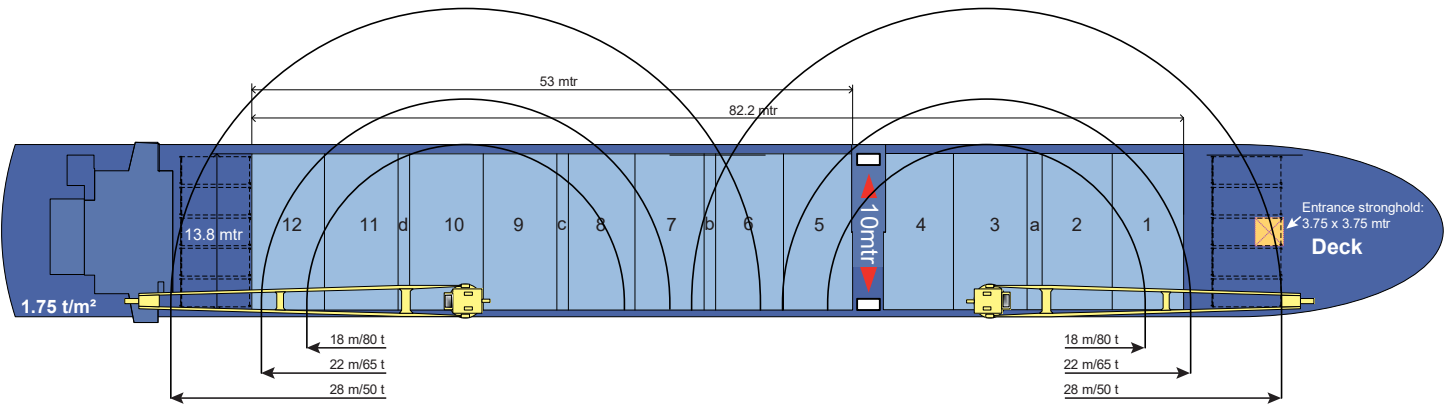
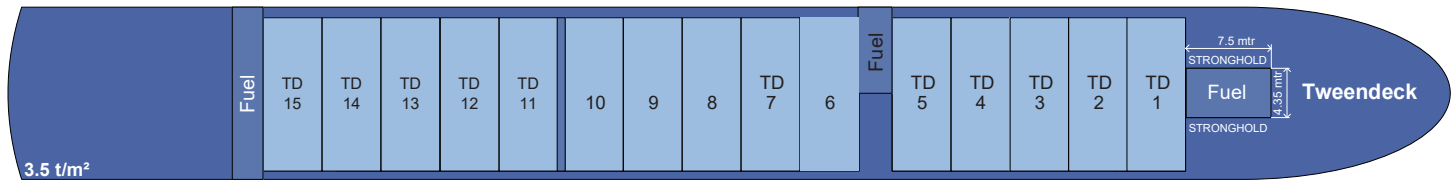
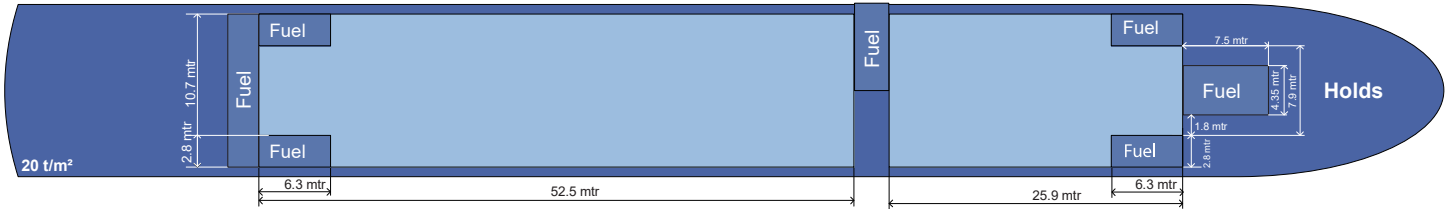
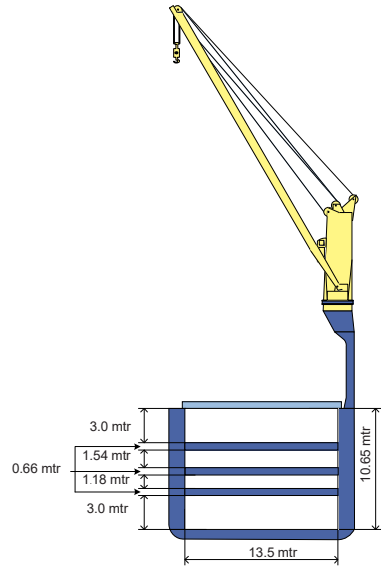

CONTAINER LOADING CAPACITY

	HOLD	DECK	TOTAL
20' BAYS	228	276	504
30' BAYS		77	77
40' BAYS	86	104	190
45' BAYS	15	48	63

STACKLOAD

	20'	40'
HOLD	100 T.	115 T.
DECK	35 T.	54 T.
	LINLOAD	LINLOAD

Note : Containerpositions regardless of sightline !

SECTION ON CENTRE LINE

BAY 17
ROWS 06, 04, 02, 01, 03, 05

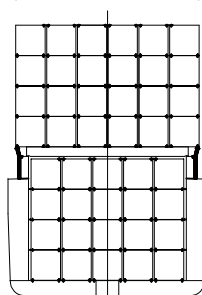

TIERS
88
86
84
82
08
06
04
02

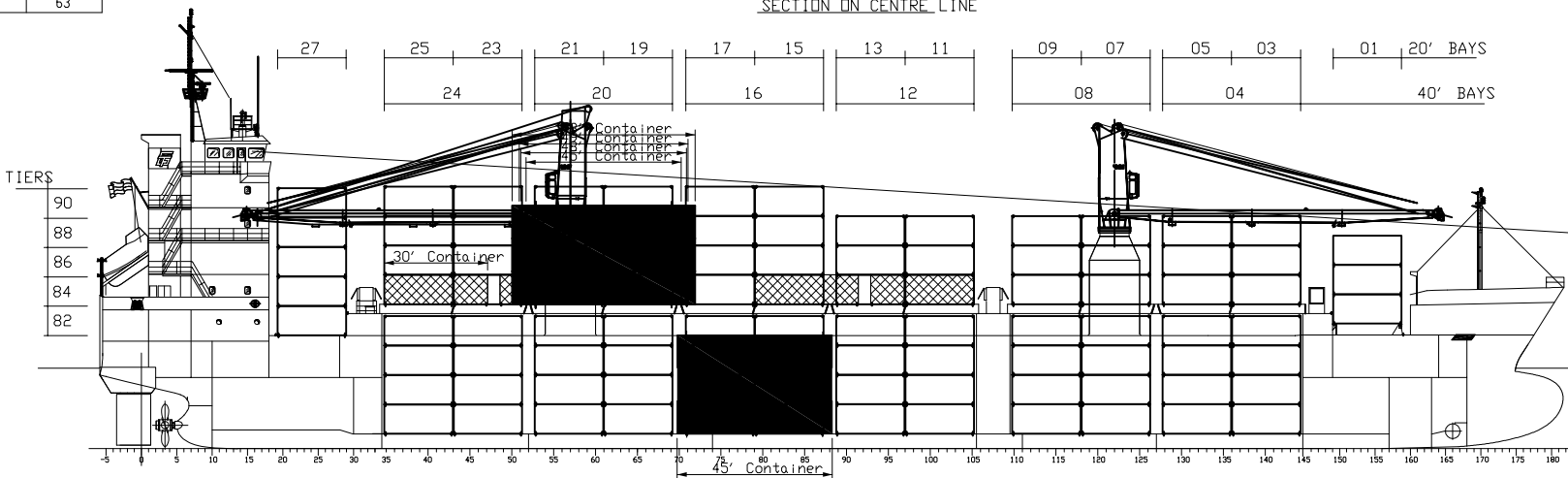

TIERS
88
86
84
82
08
06
04
02